



**RAWAD RENTAL GENERAL
CONTRACTING COMPANY**

COMPANY PROFILE

RAWAD RENTAL PROVIDES QUALIFIED CONSULTING PERSONNEL TO THE OIL, GAS, PETROCHEMICAL, INFRASTRUCTURE AND POWER INDUSTRIES SECTOR.

Rawad Rental was formed in **Saudi Arabia in 2025** and has its global headquarters in Al Khobar, registered with **CR # 7052844334**.

Our current business activities include professional services related to Civil, HVAC & Electromechanical, Electrical, Fire Protection, Piping, Plumbing, Structural, Painting and coating, Industrial Maintenance, Supply chain, and logistics, including heavy equipment rental services.



**Date
2025**

High Quality Services
Since **2025**

GET IN TOUCH



+966 53 723 3388

Al Khobar 34427, Saudi Arabia

info@rawadrental.com



**Rawad
Vision**

Expand globally, delivering exceptional services that drive unique client value.



**Rawad
Mission**

Synergizing teamwork, technology, performance, and innovation to deliver exceptional customer satisfaction.



Our Commitment

At **Rawad Rental**, we believe in building long-term partnerships through **trust, transparency, and performance**. Our goal is to contribute to the successful completion of our clients' projects by delivering dependable services that exceed expectations.

Your Trusted Partner in Contracting & Equipment Rental Solutions

Rawad Rental is a reliable and professionally managed company specializing in contracting services and rental of construction and industrial equipment. We are committed to supporting our clients with safe, efficient, and cost-effective solutions that meet the highest industry standards.

With a strong focus on quality, safety, and timely delivery, we serve a wide range of projects across construction, infrastructure, industrial, and maintenance sectors. Our experienced team and well-maintained fleet enable us to meet project demands of all sizes with confidence and precision.

This change reflects the next step in our journey — a step that resonates with our commitment to innovation, market leadership, and delivering integrated project solutions. The new name better represents the scale, direction, and diversified nature of our services as we continue to expand and elevate our offerings in the engineering and contracting sector.

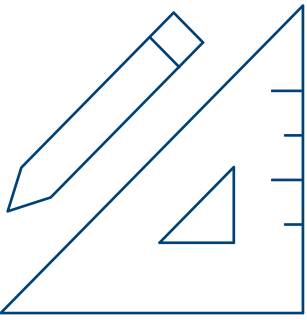

TABLE OF CONTENT

WHO WE ARE?	4
COMPANY'S STRATEGY	5
COMPANY POLICY	6
SERVICES	8
TECHNICAL INSPECTION SERVICES	8
HEAVY EQUIPMENT RENTALS & MAINTENANCE SERVICES	8
CONTRACTING (CIVIL, MECHANICAL, E&I)	9
CIVIL DIVISION	9
MECHANICAL DIVISION	10
ELECTRICAL, INSTRUMENT & TELECOMMUNICATION DIVISON	17

“Solid Values with a New Identity”



WHO WE ARE

Overview

Rawad Rental Projects Services Company (hereinafter referred to as **Rawad Rental**) is owned and managed by experienced professionals and provides highly qualified consulting and technical personnel to the **Oil, Gas, Petrochemical, Infrastructure, and Power** industry sectors.

Rawad Rental is pleased to support the industry with **skilled and competent professionals** specializing in **Contracting Management, Project Management, Materials Engineering, Welding Engineering, Materials Application, Rental Equipment supply and Logistic services**, along with **comprehensive equipment rental services**.

Established in **Saudi Arabia in 2015**, Rawad Rental's **global headquarters is located in Al Khobar**, and the company is registered under **Commercial Registration (CR) No. 7052844334**.

Rawad Rental holds approvals from several companies within the Kingdom of Saudi Arabia and delivers technical expertise to a diverse client base across the country. In addition, the company is expanding its services to the **Gulf Cooperation Council (GCC) countries and the wider Middle East region**.

Our current business activities include professional services related to **Civil, HVAC & Electro-Mechanical, Electrical, Fire Protection, Piping, Plumbing, Structural Works, Painting & Coating, Industrial Maintenance, Supply Chain & Logistics**, as well as **heavy equipment rental services**.



Company's Strategy

- ✔ Expansion of the product portfolio.
 - ✔ Persistent efforts to increase the company's market share.
 - ✔ Targeting specific customer segments.
 - ✔ Strengthening relationships with current vendors/suppliers & simultaneously developing new vendors/suppliers.
- ✔ Enhancement of Systems and Inventory management.

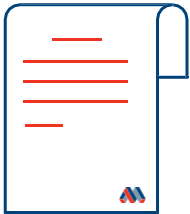

OUR MISSION

Synergizing teamwork, technology, performance, safety, and innovation to deliver exceptional customer satisfaction



OUR VISION

"Expand globally, delivering exceptional services that drive unique client value."



OUR HISTORY

High Quality Services

Since 2025

Rawad Rental
POLICIES

At Rawad Rental , we are dedicated to delivering the highest quality of service by providing our clients with the most skilled and qualified professionals in the industry. We place a strong emphasis on the ongoing development and enhancement of our team's qualifications. Our commitment to excellence drives us to offer efficient, reliable, and expert consulting services, always prioritizing total customer satisfaction.

Rawad Rental is committed to collaborating closely with clients to deliver customized solutions that align precisely with their project objectives and requirements. By emphasizing meticulous planning and execution, we ensure the highest standards of quality while proactively mitigating risks and minimizing cost overruns. Our operations are governed by a fully integrated management system, independently verified to meet the rigorous standards of ISO 9001 (Quality Management System), underscoring our dedication to excellence and continuous improvement.

OUR POLICY FRAMEWORK ENCOMPASSED THE FOLLOWING KEY PRINCIPLES:

- Compliance with all relevant laws, regulations, industry standards, and best practices is strictly adhered to.
- Rawad Rental commits to developing, implementing, and sustaining a metrics-driven IMS framework, ensuring progressive enhancement
- Our team pledges dedicated service to clients, delivering projects with excellence while embracing corporate social responsibility and sustainable development.
- We commit to maintaining exceptional HSE standards, minimizing risks, and promoting a safe, healthy, and sustainable work environment. We believe that Rawad Rental represents reliability and assurance, reflecting our dedication to delivering exceptional customer experiences.
- Rawad Rental expects all employees to perform duties safely and responsibly while committing to provide comprehensive protective measures. In exchange for employees' diligent efforts, Rawad Rental pledges to provide essential safety resources and foster open communication.

"We periodically assess and update this policy, ensuring awareness and understanding among employees, contractors, and interested parties."

Chief Executive Officer





Rawad Rental



Light Lifting Equipment Rental

Our enormous spectrum of services encompasses wide range of Light lifting equipment's rental and serves construction, Oil & Gas field & Marine Rawad Rental proficient in technical expertise and modern equipments that are reliable and offered with any time backup services, thus making us unique and preferred supplier for hiring light lifting equipments.



"we focus on delivering results with efficiency and safety in mind"

Available Equipment Range



Scissor Lifts



Man Lifts



Forklifts



Tele Handler

Transportation Equipment Rental

We are backed by trained and professional staff, and a full-pledged garage for preventive maintenance and a quality awareness team, the company serves a wide and varied clientele through out the kingdom.

We provide transportation equipments and vehicles for industrial and Official use.

Available Equipment Range

- Bus (AC/Non-AC)
- Pick Up
- Hi Ace
- Coaster
- Flat Bed Trailers
- Low Bed Trailers Boom Trucks
- Dump Trucks
- Water Tankers
- Fuel Tankers
- Vacuum Tankers



Construction Equipment Rental

In competitive industries such as industrial, construction demolition, landscaping, agriculture and more, it's critical to have access to quality



Bulldozer



Backhoe Loader



Construction Equipment Rental



Wheel Loader



Wheel Skid Loader



Road Roller



Mini Excavator



Grader



Mini Excavator

Power Equipment Rental

We understand the industry inside-out and hence can provide reliable power equipment rental. Our power equipment will help you keep your projects on track and budget. Our highly skilled technical team will ensure that your temporary power rental for your projects will run smoothly and efficiently.



Available Equipment Range



Air Compressor



Welding Machines



Tower Light



Power Generator



”

Manage your fleet
anywhere with our
Equipments



24x7 for
Better Client
Satisfaction



SERVICES

Based on the diversity and technical expertise of our staff, the following is an overview of services offered by Rawad Rental Projects Services Company

- 1. Technical Inspection Services
- 2. Heavy Equipment Rentals & Maintenance Services
- 3. Contracting (Civil, Mechanical, E&I)

1. Technical Inspection Services

- Quality Personnel's
- QHSE Personnel's
- Project Supervision (E&I, Mechanical, Civil, HVAC, Firefighting & UG/AG piping)
- In-Service Inspection
- Technical Auditing / Supplier Assessments

2. Heavy Equipment Rentals & Maintenances Services

- **Crane rental** (Mobile cranes, tower cranes, crawler cranes)
- **Excavator rental** (Backhoes, mini excavators, long reach excavator)
- **Road rollers rental** (Vibratory rollers, pneumatic rollers, single drum rollers)
- **Forklift rental** (Heavy forklift, counterbalance forklift, telescopic forklifts)
- **Drum Truck** (Rear dump truck, articulated dump truck, tailgate dump truck)



3. Contracting (Civil, Mechanical, Electrical, Instrumentation & Telecommunication)

1. Civil Division

Rawad Rental General Construction Division boasts an impressive track record of delivering high-quality services punctually and at competitive rates, cementing its position as an industry leader. With a proven commitment to innovation and excellence, Rawad Rental consistently delivers successful projects, earning a reputation as a trusted construction partner. We undertake a variety of projects for a wide range of valued clients - from small private developments to large Government projects.

Our civil engineering expertise encompasses comprehensive service solutions, including

Construction of Infrastructure Development Projects Power

- ◆ Plants & Substations
- ◆ Structures Required for Oil & Gas Industries

Our core expertise and proficiency are in the areas of Site grading

- Excavation & Backfilling
- PCC, Reinforcement & Formworks
- Concrete Works
- RCC/ Brick Drainworks
- Finishing work
-

Our Civil Turnkey Projects division is spearheaded by experienced Project Managers and supported by skilled professionals, offering comprehensive Construction, Project Management, and Maintenance services.



3. Contracting (Civil, Mechanical, Electrical, Instrumentation & Telecommunication)

2. Mechanical Division

Rawad Rental mechanical services consist of Plumbing, Piping, HVAC, Welding, Coating & Painting, Specialized fire protection services, and Industrial maintenance in addition to fabrication and installation of process pipelines and equipment.

Our core expertise and proficiency are in the areas of:

- Installation and testing of Plumbing work in Buildings.
Installation and testing of UG/AG Nonmetallic piping.
- HVAC duct fabrication, installation, air balancing, testing, and commissioning.
- Specialized Fire Safety Solutions: Sprinkler Systems, Hydrants, and Extinguishers installation.
- Process/Power piping fabrication, Welding erection, and testing.
- Protective Coatings and Painting for Industrial and Civil Infrastructure.

Rawad Rental delivers a comprehensive range of services and solutions across multiple sectors, including Power, Oil & Gas, General Industries, and Infrastructure Projects. Our operations are conducted in strict adherence to SAUDI ARAMCO standards, as well as internationally recognized codes and regulations, ensuring the highest level of quality, compliance, and reliability in every project we undertake.



I. Installation and testing of Plumbing work in Building

- PVC pipe installation for drainage network in the building.
- CPVC pipe installation for hot and cold water supply in buildings.
- Plumbing fixtures installation and testing. Hydro-testing for the installed piping.
- Functional test for the installed plumbing fixtures. Disinfection for the installed potable water pipes.

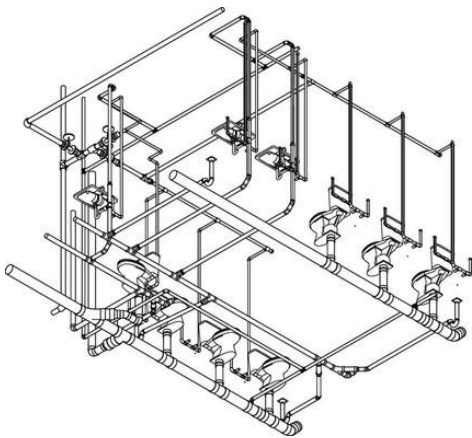
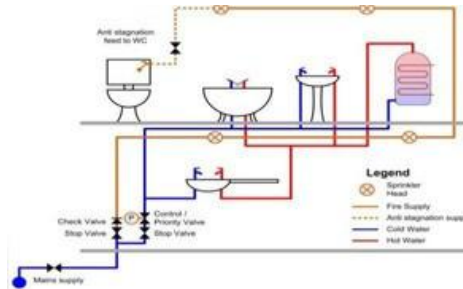

II. Installation and testing of UG/AG Non metallic Piping

- Excavation of trench for pipe laying.
- RTR (GRE, GRP, GRV) pipe laying and Installation as per approved procedure and manufacturer recommendation.
- Installation of High-Density Polyethylene Pipe (HDPE).HDPE pipe joints (Butt fusion, Electrofusion, Flange connection & Mechanical joints).
- UPVC pipe laying and installation (rubber ring joints).
- GRP Manhole and catch basin installation.
- Gravity test for the installed manhole and pipes.
- Deflection test for the installed pipes.
- Thrust Block installation for pressure piping.
- Hydrotest for the installed underground pressure pipes.



III. HVAC Duct Fabrication, Installation, Air Balancing, testing and commissioning

- HVAC duct fabrication, installation, insulation, and cladding work.
- Motorized Fire Smoke Damper, Fire Damper, Combination Fire Smoke Damper Installation, and functional testing.
- Variable Air Volume, Constant Air Volume, Duct Heater Installations.
- Wall Mounted, Floor Mounted, Roof Mounted Exhaust Fan Installation.
- HVAC Equipment Including AHU, ACCU, and Chiller Units Installation.
- Installation of Copper tube and copper piping including their Pressure testing and vacuum testing.
- Installation of Grills, Diffusers, Exhaust Air Louvers, and Fresh air Sand Trap louvers.
- Installation of DX Split Units, Ceiling suspended DX Split Units, Fan Coil Units DX Type, and Chilled Water FCU units installation.



IV. Specialized Fire Safety Solutions: Sprinkler Systems, Hydrants, and Extinguishers Installation

- Fire fighting pipe laying and installation. Sprinkler head installation and testing.
- Sprinkler system valve installation (shut off valves, zone control valves).
- Fire fighting system pump installation. Fire Alarm assembly installation.
- Fire department connection installation. Fire fighting system flushing and testing.
- Fire Hydrant and Post Indicator valves installation and testing.
- Fire Extinguisher installation.

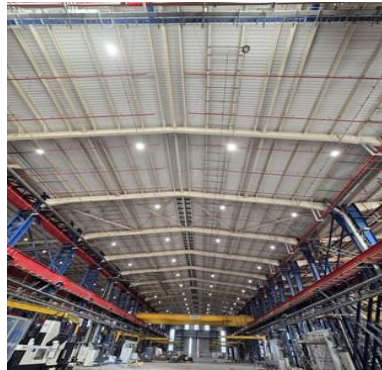
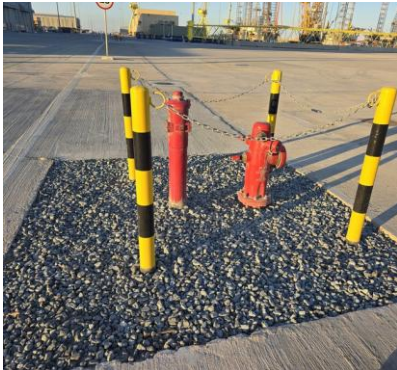

- **V. Process/Power Piping fabrication, Welding Erection and Testing**

- Pipe fabrication and spool preparation.
- Internal cleaning of pipes before installation.
- Process/Power piping Erection.
- Hydro-testing of installed process piping.
- Piping lay-up after testing.

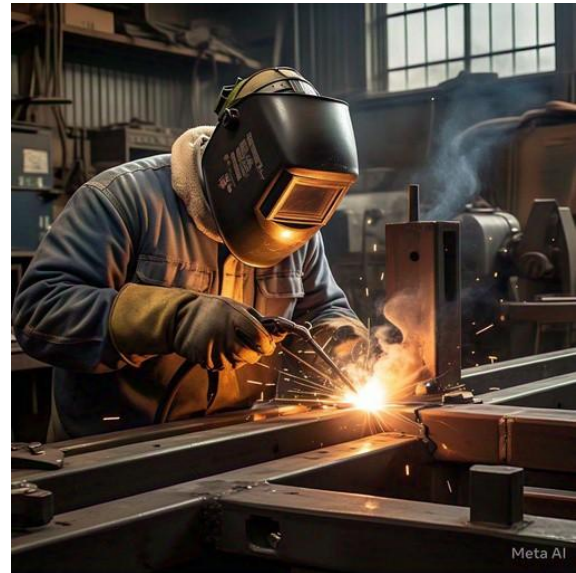

VI. Protective Coatings and Painting For Industrial and Civil Infrastructure

Coating application for industrial plants and equipments.
Internal and External coating for the pipelines and piping.
Protective coating for industrial concrete structure.
Viscoelastic protective coating for the buried services.
Perform testing (holiday, chloride, abrasive test).



3. Electrical, Instrumentation & Telecommunication Divisions:

Rawad Rental through its Electrical Projects department provides a portfolio of services in all phases of Electrical, Instrument and Telecommunication Construction activities. Our staff is continuously educated and familiar with NEC/ IEC / IEEE / BS / NEMA standards.

1. Electrical, Instrumentation

Our Expertise & Proficiency are in the areas of,

- Design, supply, and installation of comprehensive cabling solutions, including cable trays, trunking systems, and conduits.
- Design, supply, installation, testing and commissioning of low-voltage (LV) and medium-voltage (MV) electrical infrastructure.
- Comprehensive electrical and instrumentation services, including excavation, cable laying, cable management, and power distribution systems.
- High-Voltage Cable Termination and Jointing Services (up to 33kV and 36kV) and Industrial Automation Solutions.
- Turnkey Solutions: Integration, Installation, Commissioning and Start-up Services.
- Expert Transformer Revamping: Oil Filtration, Repair, and Maintenance for 400 MVA Transformers.
- Low voltage power panel installation and pre-commissioning.
- Instrument transmitter, gauges installation and testing.
- Fire Alarm and Gas detection system installation, testing, and pre-commissioning.

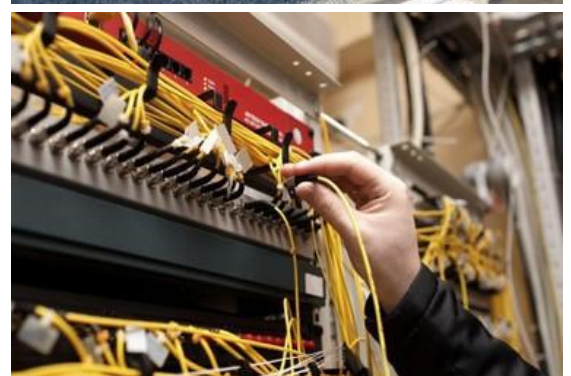

3. Electrical, Instrumentation & Telecommunication Divisions:

Rawad Rental through its Electrical Projects department provides a portfolio of services in all phases of Electrical, Instrumentation and Telecommunication Construction activities. Our staff is continuously educated and familiar with NEC/ IEC / IEEE / BS / NEMA standards.

3.2 Telecommunication

Our Expertise & Proficiency are in the areas of:

- Design, supply, and installation of comprehensive cabling solutions, including cable trays, trunking systems, and conduits.
- Comprehensive telecommunication services, including excavation, cable laying, cable management, and duct bank installation.
- High density drilling and sleeve installation for fiber optic cables. Mandrel test for the installed sleeve and duct banks.
- Sub-duct installation for the telecommunication cabling system. Fiber optic cable splicing and testing.
- Service post indicator markers installation.
- Telecommunication cabinet installation, cabling connection, and pre-commissioning.
- Speakers and beacon installation and testing for telecommunication.



Rawad Rental specializes in providing
Aramco-approved QC personnel,
subcontracting services, and industrial
solutions tailored to the contracting sector
in Saudi Arabia."

GET IN TOUCH



Tel: +966 53 723 3388



www.RawadRental.com



Al Khobar 34427, Saudi
Arabia



info@RawadRental.com



GET IN TOUCH

Rawad Rental
WEBSITE